

# Manitowoc Cranes

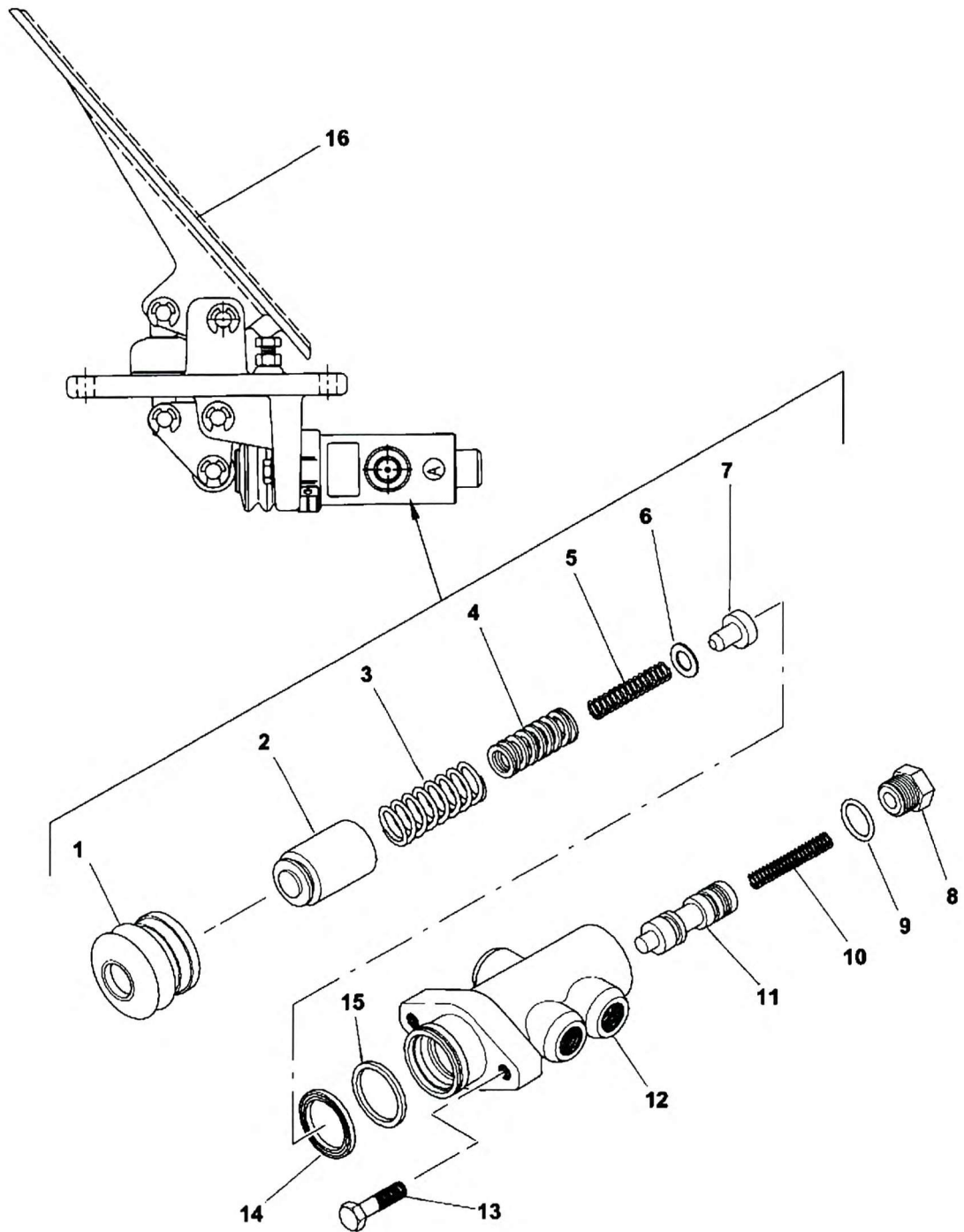

1101384

(SHEET 1 OF 1)

Page 210